

Jar-Master

11/88
SNF-7534

Alfa-Laval Agri, Inc.
Kansas City, Missouri

 DE LAVAL

INTRODUCTION

The Jar-Master™ is used in milking parlors, and allows individual check of milk yield and butter fat sampling.

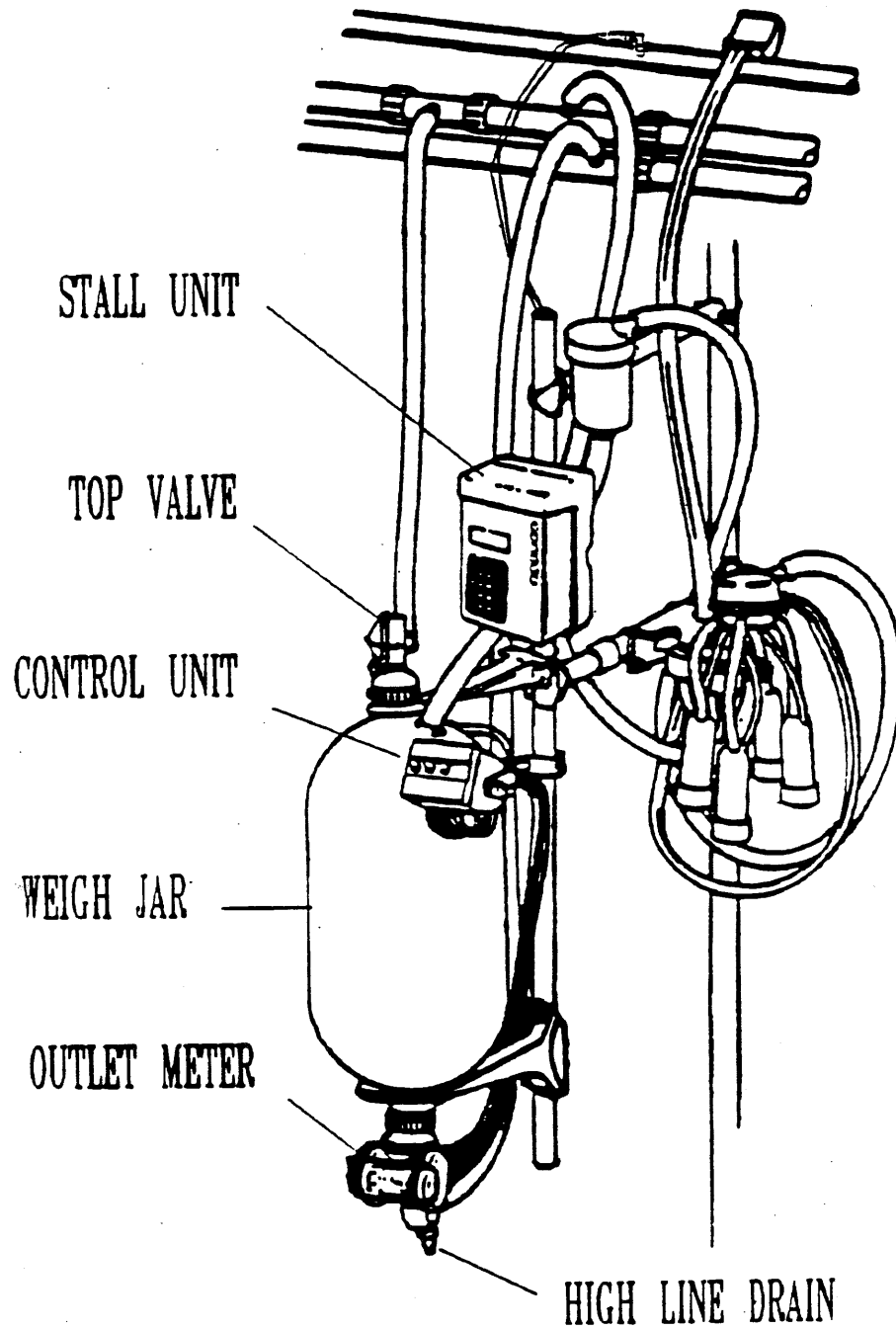

OPERATION

Preparation

Before milking

- Separate cleaning cups and teat cups.
- Close the cleaning system and open the milking system.
- Unlock the shut-off valves on all the milk claws to milking position.

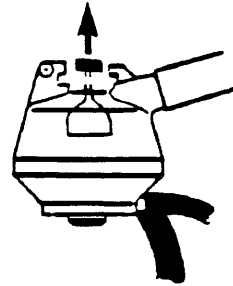
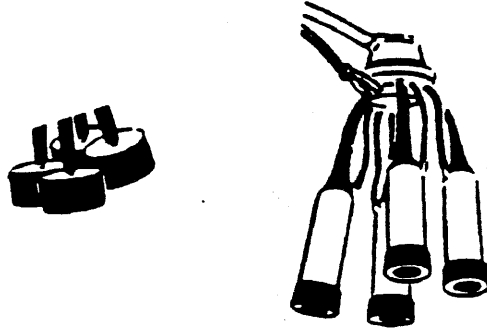

- Start the vacuum pump.

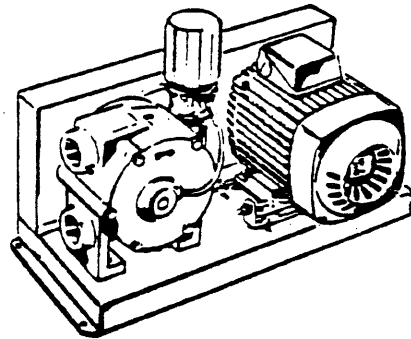

Milking

- Prepare the cow.

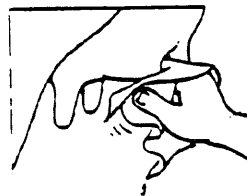

- Set all switches in milking position.

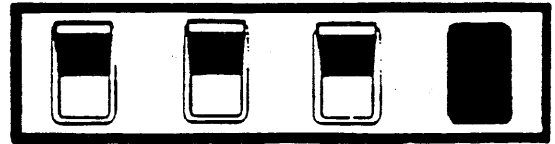

Note: In the event of vacuum loss or as a precaution against vacuum loss, manually clamp the milking line to prevent milk from draining into the milking line or onto the floor.

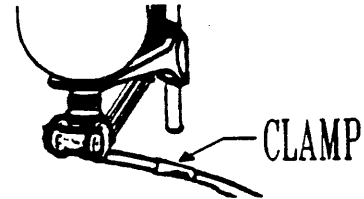

- Put on the milking unit.

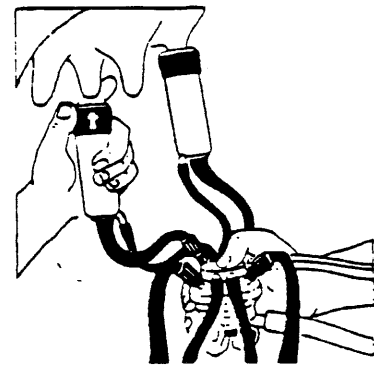

Recording.

- When the milking is completed press down the extreme left toggle switch on the control unit.

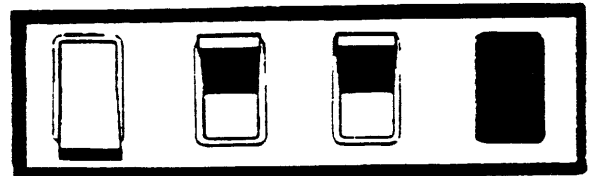

- The outlet meter starts emptying the glass jar, and the display unit counts the milk yield. Display does not show until after 10 strokes.

When recording is finished read off the milk yield on the display. The display shows the milk yield in pounds with one decimal about 5 seconds after the meter stops.

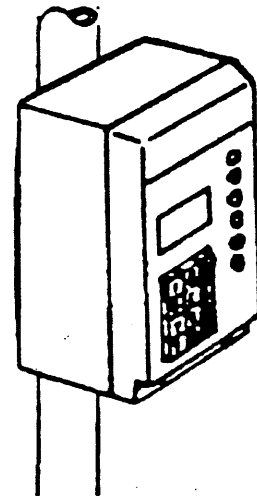

Milk Sweep - Emptying of Residual milk after last milking

- When the last cow is milked, set the toggle switches in this position to remove residual milk from the piping system to the end unit.

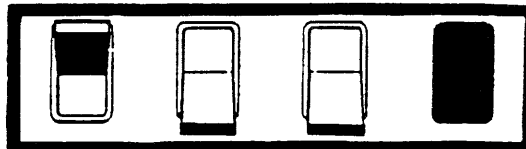

Cleaning

- Lock the shut-off valves in open position on all the milk claws.

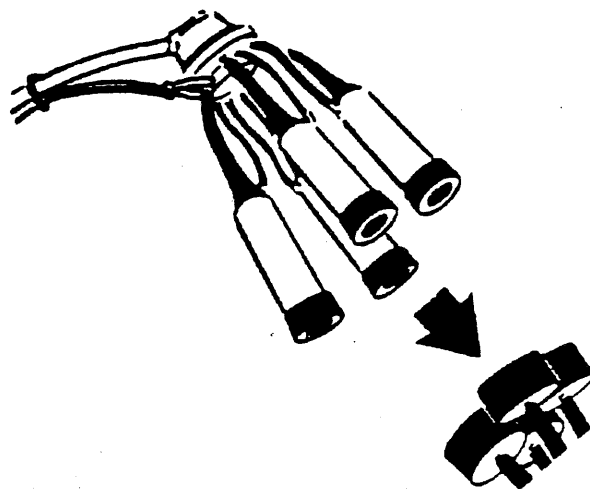
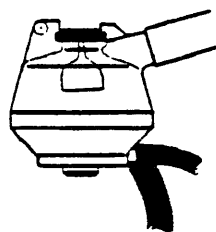

- Place the teat cups into the Jetter cups.

- Set the toggle switches in this position before start of cleaning.

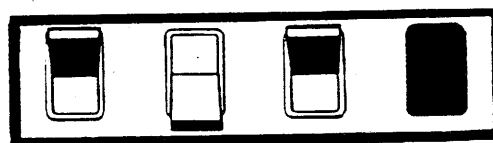

Dumping & Fat Sampling

Dumping of milk

- If for any reason the collected milk in the weigh jar is not wanted in the milk tank, it can be dumped
- Units with external drain, remove hose from meter.
- Units without external drain, remove outlet hose from the low line.
- Set the toggle switches according to the adjoining picture.
First the switch marked III, allow vacuum to decay, then the switch marked II.

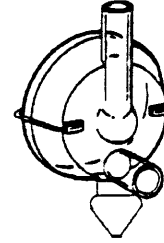

2nd ← 1st
Order of Sequence

Fat Sampling

- Open the plug in the Outlet Meter and connect the plastic tube with the hose adapter. The plastic tube is equipped with a clip and a short outer tube. The short outer tube is equipped with an air bleed which contains a small hole.
- During milking all switches are in upper position and the clip is open. The milk is continuously mixed by air through the small hole in the plug. (0.20-0.25 CFM)
- When milking is finished and a sample shall be taken, remove the short outer tube with plug and place the free tube end over a bottle.
- Press the third switch and atmospheric pressure is let in, and milk is transferred to the bottle.

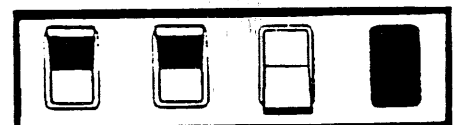
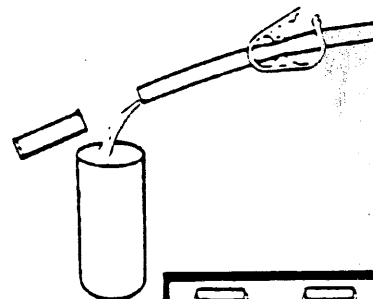
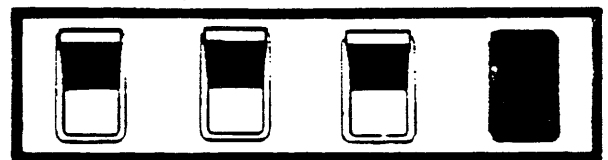
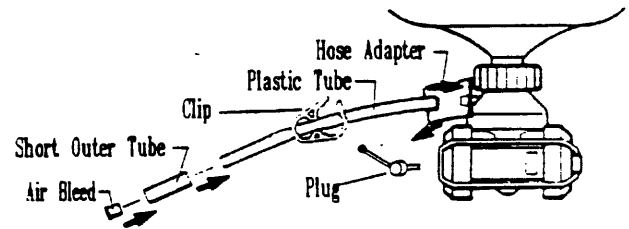

- When an appropriate amount is filled, lift the third switch to upper position and immediately shut the clip.

- Put back the shorter outer tube and be sure the plug is in place and the hole is clean and open.







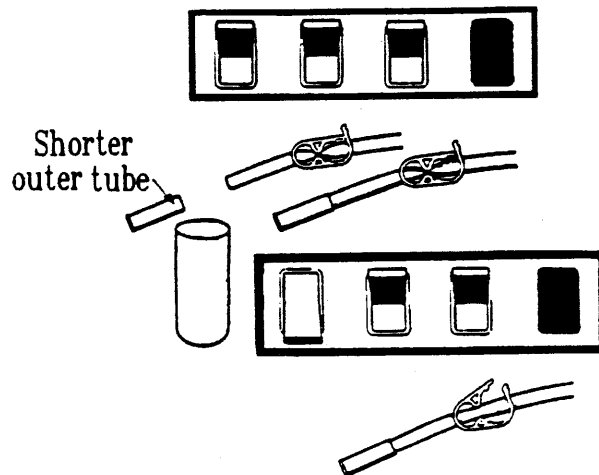

























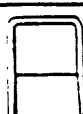

- The milk is recorded.

Note: The meter must not be started with the clip open as air will be drawn into the piston chamber.

- Before next cow is milked open the clip.



Summary of Operational Functions of Control Box

					Milking
					Recording
					Milk Sweep (Emptying of residual milk after last milking)
					Cleaning
					Dumping
					Mixing
					Sampling

Program Function

(Refer to Program Functions Section in YieldMaster manual)

1. *F4 Jar-Master™*
Does not drain down the meter. It is a way for the operator to manually signal the end of the cow's milkweight.
2. *F4 Jar-Master™/AutoID*
In an Auto ID, if a Jar-Master™ Stall Unit gives no milkweight before the next cow is ID'd, the operator must check if the meter still has milk in it. If the meter still holds milk, the operator simply starts the measurement and the system will automatically finalize the measurement. If there was NO milk in the jar, then operator must do an F4 to finalize the Stall Unit.

Operation Notes

With Automatic ID (Portal)

1. The single most important procedure to assure that ID is correct is that the operator must look at the Stall Unit nearest the entrance gate after the complete string of cows has entered. Verify that the correct cow ID is displayed on that Stall Unit.

Also the cow must be confirmed by the status lights turning off except for low yield light.

This simple routine identifies problems when they are correctable. It not only verifies the ID system but also verifies that all the previous cows' milkweights have been measured.

2. At least one meter must be started and register some milkweight before the exit gate is opened, or the ID buffering will not work properly.
3. Once a meter has measured and the exit gate has opened the YieldMaster will make the decision that the Stall Unit is ready to receive the next auto ID. If, for any reason, there is milk remaining in the jar at this point, the next ID could come in before it is measured.

This situation is not likely to occur, but if the operation or maintenance of the meters presents this situation frequently, then the operators would have to assure that no milk is remaining before the exit gate opens.

4. During milking, the operators must respond to the EEEE messages as they occur or the Auto ID will not work properly.
5. The portal curtain must not be energized by the Entrance gate switch until the exit gate has been open for about four or five seconds. The first cow into the portal curtain must be picked up while the curtain is energized, otherwise the first cow may be missed.

Different parlors have layouts where this may be difficult, so that operator intervention may be necessary to ensure 100 percent ID.

6. Do not print lists when a new string of cows is coming in. The printout slows the ID updating down if done at that time.

NOTE:

With Stand Alone, Manual ID and Individual ID; operator must start up system manually.

De Laval Jar-Master Water Calibration

1. Fill each jar with over 8 lbs. of water.
2. Allow water to stand for 5 minutes to eliminate vortexes during metering.
3. Meter water out of jar allowing it to shut-off automatically.
4. Measure 22.0 lbs of water with an accurate scale. Fill each jar with 22.0 lbs of water at a temperature between 60°F and 75°F.
5. Allow water to stand for 5 minutes to eliminate vortexes during metering.
6. Meter water out of jar and record meter readout. Meter should read somewhere from 21.8 to 23.1.
7. If meter reading is not correct, repeat the procedure twice to verify that the procedure was done correctly.

Note: Perform De Laval Jar-Master water calibration procedure after installation and at yearly intervals or as needed.

